

Resistance thermometer Industrial assembly Model TR10-0

WIKA data sheet TE 61.01



for further approvals
see page 11

Applications

- Chemical and petrochemical industries
- Machinery, plant and tank measurement
- Oil and gas industries
- Power and utilities
- Pulp and paper

Special features

- Sensor ranges from -196 ... +600 °C [-321 ... +1,112 °F]
- For mounting in all standard thermowell designs
- Spring-loaded measuring insert (replaceable)
- Fixed fitting (welded) measuring insert
- Explosion-protected versions are available for many approval types (see page 2)



**Resistance thermometer, industrial assembly,
model TR10-0**

Description

Resistance thermometers in this series can be combined with a large number of thermowell designs. Use without a thermowell is permitted when using a fixed (welded) fitting.

A wide variety of possible combinations of sensor, connection head, insertion length, neck length, connection to thermowell etc. are available for the thermometers; suitable for almost any thermowell dimension.

Optionally we can fit transmitters from the WIKA range into the connection head of the TR10-0.

Representation of the components

Tapered threads

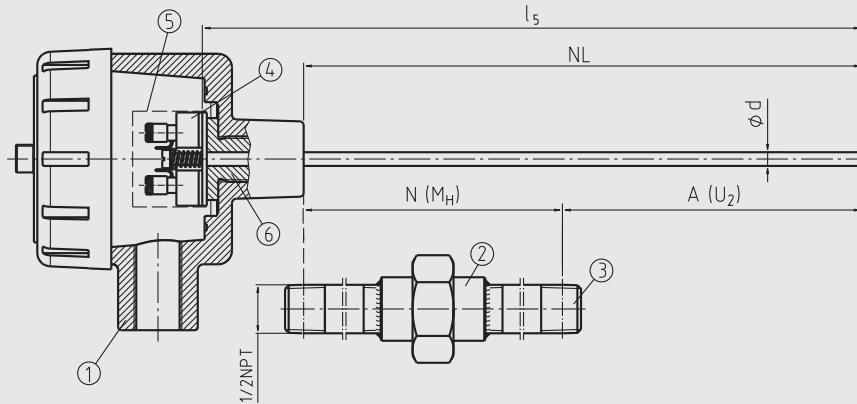

3112147.02

Parallel threads

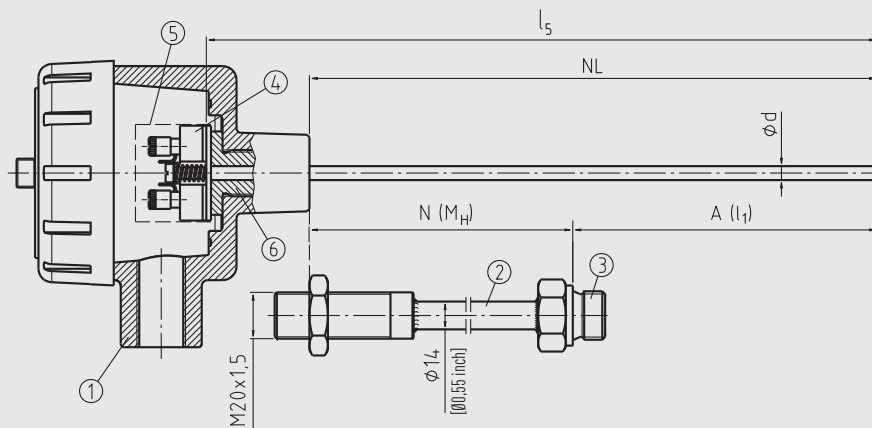

3112287.01

Legend:

- | | |
|----------------------------|---|
| ① Connection head | A (U ₂) Insertion length (tapered threads) |
| ② Neck tube | A (l ₁) Insertion length (parallel threads) |
| ③ Connection to thermowell | l ₅ Measuring insert length |
| ④ Measuring insert | Ø d Measuring insert diameter |
| ⑤ Transmitter (option) | NL Nominal length |
| ⑥ Flame path fitting | N (M _H) Neck length |

Overview of approvals for explosion protection

Approval	Explosion protection					
	Ex i (gas) Zone 0, 1, 2	Ex i (dust) Zone 20, 21, 22	Ex d (gas) Zone 1, 2	Ex d (dust) Zone 21	Ex e (gas) Zone 1, 2	Ex n (gas) Zone 2
ATEX	x	x	x	x	x	x
IECEX	x	x	x	x	x	x
FM	-	-	x	x	-	-
CSA	-	-	x	x	-	-
EAC	x	x	x	x	-	x
Ex Ukraine	x	x	x	x	-	-
INMETRO	x	x	-	-	-	-
CCC	x	x	x	x	x	x

→ For detailed information, see page 11

Measuring element

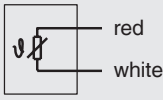
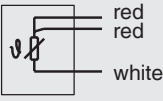
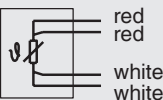
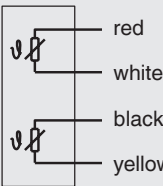
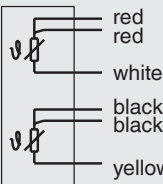
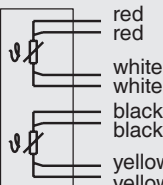
Measuring element		
Type of measuring element	Pt100, Pt1000 ¹⁾	
Measuring current	0.1 ... 1.0 mA	
Connection method		
Single elements	1 x 2-wire	
	1 x 3-wire	
	1 x 4-wire	
Dual elements	2 x 2-wire	
	2 x 3-wire	
	2 x 4-wire ²⁾	
Validity limits of the class accuracy in accordance with EN 60751		
Class B	Wire-wound	-196 ... +600 °C [-321 ... +1,112 °F]
	Thin-film	-50 ... +500 °C [-58 ... +932 °F]
Class A ³⁾	Wire-wound	-100 ... +450 °C [-148 ... +842 °F]
	Thin-film	-30 ... +300 °C [-22 ... +572 °F]
Class AA ³⁾	Wire-wound	-50 ... +250 °C [-58 ... +482 °F]
	Thin-film	0 ... 150 °C [-32 ... +302 °F]

1) Pt1000 only available as a thin-film measuring resistor

2) Not for 3 mm [1/8"] diameter

3) Not with 2-wire connection method



→ For detailed specifications for Pt100 sensors, see Technical information IN 00.17 at www.wika.com.

The table shows the temperature ranges listed in the respective standards, in which the tolerance values (class accuracies) are valid.

- The combinations of a 2-wire connection with class A or class AA are not permissible, since the lead resistance of the MI cable and the connection lead negates the higher sensor accuracy.
- When using a 3-wire connection, we recommend not to exceed a probe length, including the connection cable, of approx. 30 m [100 ft].
- Longer probe/cable lengths should be designed with a 4-wire connection.

Connection head

European designs per EN 50446 / DIN 43735

Model	Material	Cable entry thread size	Ingress protection (max.) ¹⁾ IEC/EN 60529	Cap	Surface	Connection to neck tube
 BS	Aluminium	■ M20 x 1.5 ■ ½ NPT	IP65 ²⁾	Flat cover with 2 screws	Blue, painted (RAL 5022)	M24 x 1.5
 BSZ	Aluminium	■ M20 x 1.5 ■ ½ NPT	IP65 ²⁾	Spherical hinged cover with cylinder head screw	Blue, painted (RAL 5022)	M24 x 1.5
 BSZ-H	Aluminium	■ M20 x 1.5 ■ ½ NPT	IP65 ²⁾	Raised hinged cover with cylinder head screw	Blue, painted (RAL 5022)	M24 x 1.5

Model	Explosion protection						
	Without	Ex i (gas) Zone 0, 1, 2	Ex i (dust) Zone 20, 21, 22	Ex d (gas) Zone 1, 2	Ex d (dust) Zone 21	Ex e (gas) Zone 1, 2	Ex nA (gas) Zone 2
BS	x	x	x	-	-	-	-
BSZ	x	x	x	-	-	x ³⁾	x ⁴⁾
BSZ-H	x	x	x	-	-	x ³⁾	x ⁴⁾

1) IP ingress protection of the connection head. The IP ingress protections of the complete instrument TR10-B must not inevitably correspond to the connection head.





2) Ingress protections, describing temporary or permanent immersion, on request

3) Only ATEX and CCC

4) Only ATEX, CCC and EAC-Ex

Other connections heads are available.

North American designs

Model	Material	Cable entry thread size	Ingress protection (max.) ¹⁾ IEC/EN 60529	Cap	Surface	Connection to neck tube
	KN4-A	Aluminium	■ ½ NPT ■ M20 x 1.5	IP65 ³⁾	Screw-on lid	Blue, painted (RAL 5022) ■ M24 x 1.5 ■ ½ NPT
	KN4-P ²⁾	Polypropylene	½ NPT	IP65 ³⁾	Screw-on lid	White ½ NPT
	1/4000 F	Aluminium	■ ½ NPT ■ ¾ NPT ■ M20 x 1.5	IP66 ³⁾	Screw cap	Blue, painted (RAL 5022) ½ NPT
	1/4000 S	Stainless steel	■ ½ NPT ■ ¾ NPT ■ M20 x 1.5	IP66 ³⁾	Screw cap	Natural finish ½ NPT
	7/8000 W	Aluminium	■ ½ NPT ■ ¾ NPT ■ M20 x 1.5	IP66 ³⁾	Screw cap	Blue, painted (RAL 5022) ½ NPT
	7/8000 S	Stainless steel	■ ½ NPT ■ ¾ NPT ■ M20 x 1.5	IP66 ³⁾	Screw cap	Natural finish ½ NPT
	7/8000 W / DIH50 ⁴⁾	Aluminium	■ ½ NPT ■ ¾ NPT ■ M20 x 1.5	IP66 ³⁾	Screw-on lid	Blue, painted (RAL 5022) ½ NPT
	7/8000 S / DIH50 ⁴⁾	Stainless steel	■ ½ NPT ■ ¾ NPT ■ M20 x 1.5	IP66 ³⁾	Screw-on lid	Natural finish ½ NPT

Model	Explosion protection						
	Without	Ex i (gas) Zone 0, 1, 2	Ex i (dust) Zone 20, 21, 22	Ex d (gas) Zone 1, 2	Ex d (dust) Zone 21	Ex e (gas) Zone 1, 2	Ex nA (gas) Zone 2
KN4-A	x	x	-	-	-	-	-
KN4-P ²⁾	x	-	-	-	-	-	-
1/4000 F	x	x	x	x	x	x	x
1/4000 S	x	x	x	x	x	x	x
7/8000 W	x	x	x	x	x	x	x
7/8000 S	x	x	x	x	x	x	x
7/8000 W / DIH50 ⁴⁾	x	x	x	x	-	-	-
7/8000 S / DIH50 ⁴⁾	x	x	x	x	-	-	-

1) IP ingress protection of the connection head. The IP ingress protections of the complete instrument TR10-0 must not inevitably correspond to the connection head.

2) On request

3) Suitable sealing/cable gland required

4) LC display DIH50

Other connections heads are available.

Measuring insert

Measuring insert		
Versions	Vibration-resistant, sheathed measuring cable (MI cable)	
Optimal heat transfer	Requirement <ul style="list-style-type: none"> ■ Correct measuring insert length ■ Correct measuring insert diameter 	
	Bore diameter of the thermowell	Max. 1 mm [0.04 in] larger than measuring insert diameter
	Joint width	For joint width > 0.5 mm [> 0.02 in] between thermowell and measuring insert: → Negative impact on heat transfer → Unfavourable response behaviour of the thermometer
Measuring insert diameter $\varnothing d$	<ul style="list-style-type: none"> ■ 3.0 mm ■ 6.0 mm ■ 8.0 mm ■ 1/8 in or 0.125 in [3.17 mm] ■ 3/16 in or 0.188 in [4.75 mm] ■ 1/4 in or 0.250 in [6.35 mm] 	
	Other measuring insert diameters on request	
Insertion length	When fitting the measuring insert into a thermowell, it is very important to determine the correct insertion length (= thermowell length for bottom thicknesses of ≤ 5.5 mm [≤ 0.22 in]). In order to ensure that the measuring insert is firmly pressed down onto the bottom of the thermowell, the insert must be spring-loaded (spring travel: 0 ... 10 mm [0 ... 0.39 in]).	
Spring travel		
Spring-loaded plate	Max. 10 mm [0.39 in]	
Self gripping spring	Max. 20 mm [0.79 in]	

Ex d version: Due to the use of a flame path fitting and its fitting tolerances, the use of standard measuring inserts for replacement requirements is not allowed!

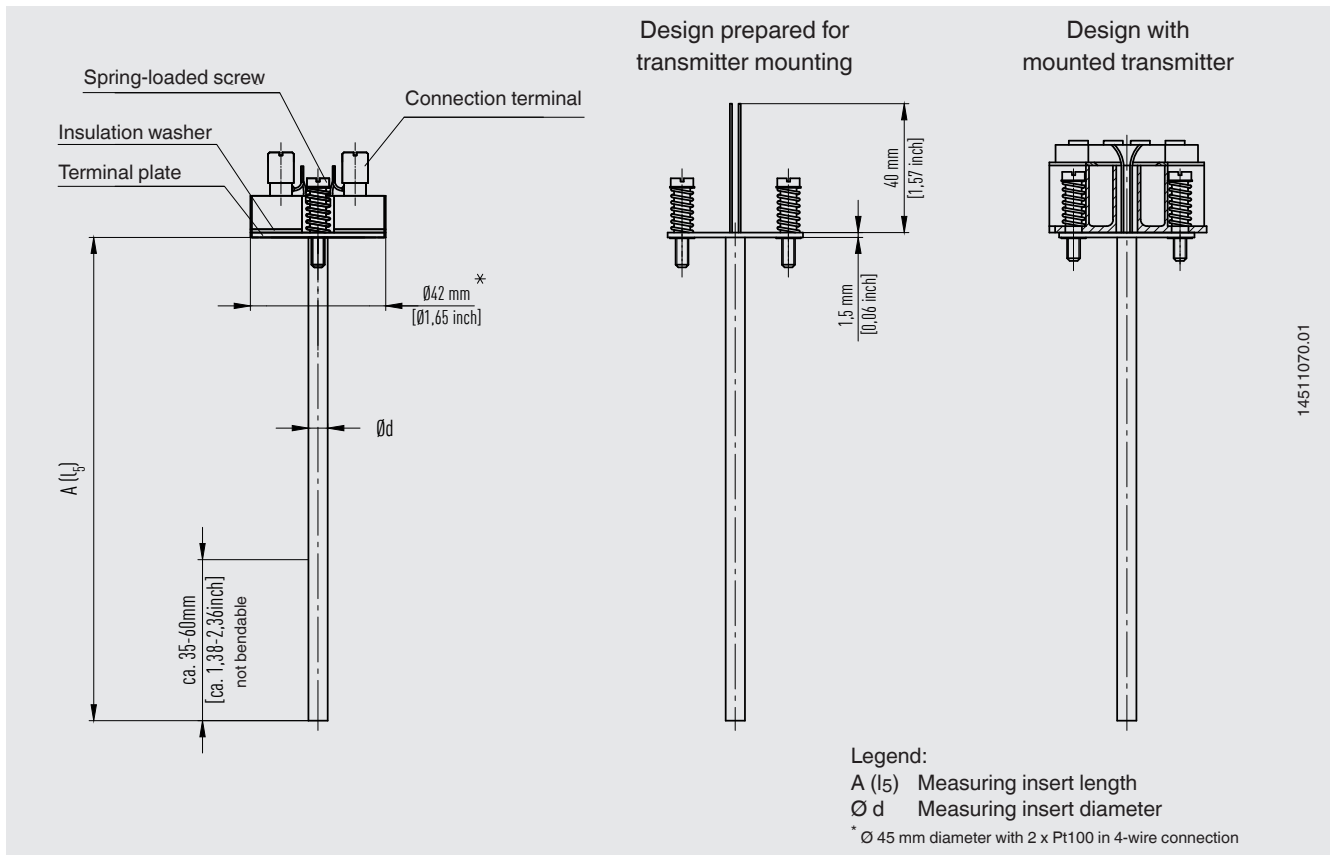

Transmitter

Transmitter models	Model T15	Model T32
Transmitter data sheet	TE 15.01	TE 32.04
Figure		
Output		
4 ... 20 mA	x	x
HART® protocol	-	x
Connection method	<ul style="list-style-type: none"> ■ 1 x 2-wire ■ 1 x 3-wire ■ 1 x 4-wire 	<ul style="list-style-type: none"> ■ 1 x 2-wire ■ 1 x 3-wire ■ 1 x 4-wire ■ 2 x 2-wire
Measuring current	< 0.2 mA	< 0.3 mA
Explosion protection	Option	Option

Possible mounting positions for transmitters	Model T15	Model T32
BS	○	-
BSZ	○	○
BSZ-H	●	●
KN4-A	○	○
1/4000	○	○
1/4000 with DIH50	○	○
7/8000	○	○
7/8000 with DIH50	○	○

Legend:

- Mounted instead of terminal block
- Mounted within the cover of the connection head
- Mounting not possible

The mounting of a transmitter on the measuring insert is possible with all the connection heads listed here. The fitting of a transmitter in the (screw) cap of a North American design connection head is not possible.

Mounting of 2 transmitters on request.

For a correct determination of the overall measuring deviation, the sensor and transmitter measuring deviations must be added.

Functional safety with model T32 temperature transmitter (option)



In safety-critical applications, the entire measuring chain must be taken into consideration in terms of the safety parameters. The SIL classification allows the assessment of the risk reduction achieved by the safety installations.

→ For detailed specifications, see Technical information IN 00.19 at www.wika.com.

Selected TR10-0 resistance thermometers, in combination with a suitable temperature transmitter (e.g. model T32.1S, TÜV certified SIL version for protection systems developed in accordance with IEC 61508), are suitable as sensors for safety functions to SIL 2.

Neck tube

Versions

Neck tube design	Diameter	Connection to head	Connection to thermowell	Material
Neck tube with counter nut to head	14 x 2.5 mm [0.55 x 0.09 in]	M20 x 1.5 (with counter nut)	Mounting thread	1.4571
Double threaded hex bushing (with hexagonal spanner flats)	-	M24 x 1.5, ½ NPT	Mounting thread	1.4571
“Nipple-union-nipple” neck tube	~ 22 mm [0.87 in]	½ NPT	Mounting thread	316
	~ 27 mm [1.06 in]	¾ NPT	Mounting thread	316
Double threaded hex bushing (tube section)	~ 22 mm [0.87 in]	½ NPT	Mounting thread	316
	~ 27 mm [1.06 in]	¾ NPT	Mounting thread	316

Thread sizes

Neck tube design	Diameter	Thread to the thermowell
Neck tube with counter nut to head	14 x 2.5 mm [0.55 x 0.09 in]	<ul style="list-style-type: none"> ■ ½ NPT ■ ¾ NPT ■ G ½ B ■ G ¾ B ■ G ¼ B ■ M14 x 1.5 ■ M18 x 1.5 ■ M20 x 1.5
Double threaded hex bushing (with hexagonal spanner flats)	-	<ul style="list-style-type: none"> ■ G ½ B ■ G ¾ B ■ G ¼ B ■ ½ NPT ■ ¾ NPT ■ M14 x 1.5 ■ M18 x 1.5 ■ M20 x 1.5
“Nipple-union-nipple” neck tube	~ 22 mm [0.87 in]	½ NPT
	~ 27 mm [1,06 in]	¾ NPT
Double threaded hex bushing (tube section)	~ 22 mm [0.87 in]	½ NPT
	~ 27 mm [1,06 in]	¾ NPT

Neck lengths

Neck tube design	Neck length	Min. / Max. neck length
Neck tube with counter nut to head	150 mm [approx. 6 in]	75 mm [approx. 3 in] / 250 mm [approx. 10 in]
Double threaded hex bushing (with hexagonal spanner flats)		
M24 x 1.5 to connection head, parallel thread to thermowell	13 mm [0.51 in]	-
1/2 NPT to connection head, parallel thread to thermowell	25 mm [0.98 in]	-
M24 x 1.5 to connection head, tapered thread to thermowell	25 mm [0.98 in]	-
1/2 NPT to connection head, tapered thread to thermowell	25 mm [0.98 in]	-
“Nipple-union-nipple” neck tube	150 mm [approx. 6 in]	75 mm [approx. 3 in] / 250 mm [approx. 10 in]
Double threaded hex bushing (tube section)	50 mm [approx. 2 in]	50 mm [approx. 2 in] / 250 mm [approx. 10 in]

The neck tube is screwed into the connection head. The neck length depends on the intended use. Usually an isolation is bridged by the neck tube. Also, in many cases, the neck tube serves as a cooling extension between the connection head and the medium, in order to protect a possible built-in transmitter from high medium temperatures.

Other versions on request

Operating conditions

Operating conditions	
Ambient and storage temperature	-40 ... +80 °C [-40 ... +176 °F]
Vibration resistance	The information on vibration resistance refers to the tip of the measuring insert. → For detailed specifications on the vibration resistance of Pt100 sensors, see Technical information IN 00.17 at www.wika.de .
Standard	6 g peak-to-peak, wire-wound measuring resistor or thin film
Option	<ul style="list-style-type: none"> ■ Vibration-resistant probe tip, max. 20 g peak-to-peak, thin-film measuring resistor ■ Highly vibration-resistant probe tip, max. 50 g peak-to-peak, thin-film measuring resistor

IP ingress protection per IEC/EN 60529

First index number	Degree of protection / Short description	Test parameters
Degrees of protection against solid foreign bodies (defined by the 1st index number)		
5	Dust-protected	Per IEC/EN 60529
6	Dust-tight	Per IEC/EN 60529
Degrees of protection against water (defined by the 2nd index number)		
4	Protected against splash water	Per IEC/EN 60529
5	Protected against water jets	Per IEC/EN 60529
6	Protected against strong water jets	Per IEC/EN 60529
7 ¹⁾	Protected against the effects of temporary immersion in water	Per IEC/EN 60529
8 ¹⁾	Protected against the effects of permanent immersion in water	As agreed upon







1) Ingress protections, describing temporary or permanent immersion, on request

Standard ingress protection of model TR10-0 is IP65.

The specified degrees of protection apply under the following conditions:

- Use of a suitable thermowell
(without suitable thermowell: IP40)
- Use of a suitable cable gland
- Use of a cable cross-section appropriate for the gland or select the appropriate cable gland for the available cable
- Adhere to the tightening torques for all threaded connections

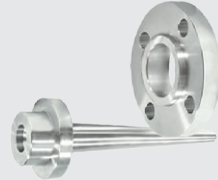
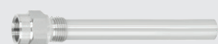
Thermowell (option)





Thermowell selection		
Model	Data sheet	Illustration
TW10	TW 95.10	
TW15	TW 95.15	
TW20	TW 95.20	
TW25	TW 95.25	
TW30	TW 95.30	
TW31	TW 95.31	
TW50	TW 95.50	
TW55	TW 95.55	









Special thermowells on request

Approvals

Logo	Description	Country
	EU declaration of conformity	European Union
	EMC directive ¹⁾ EN 61326 emission (group 1, class B) and immunity (industrial application)	
	RoHS directive	

Optional approvals

Logo	Description	Country				
	EU declaration of conformity	European Union				
	ATEX directive					
	Hazardous areas					
	- Ex i		Zone 0 gas Zone 1 mounting to zone 0 gas Zone 1 gas Zone 20 dust Zone 21 mounting to zone 20 dust Zone 21 dust	II 1G Ex ia IIC T1 ... T6 Ga II 1/2G Ex ia IIC T1 ... T6 Ga/Gb II 2G Ex ia IIC T1 ... T6 Gb II 1D Ex ia IIIC T125 ... T65 °C Da II 1/2D Ex ia IIIC T125 ... T65 °C Da/Db II 2D Ex ia IIC T125 ... T65 °C Db		
	- Ex d		Zone 1 gas Zone 1 gas Zone 21 dust	II 2G Ex db IIB + H2 T6 ... T4 Gb II 2G Ex db IIC T6 ... T4 Gb II 2D Ex tb IIIC T85 °C Db IP66		
	- Ex e		Zone 1 gas Zone 2 gas Zone 21 dust Zone 22 dust	II 2G Ex eb IIC T1 ... T6 Gb ³⁾ II 3G Ex ec IIC T1 ... T6 Gc X II 2D Ex tb IIIC TX °C Db ³⁾ II 3D Ex tc IIIC TX °C Dc X		
	- Ex n		Zone 2 gas Zone 22 dust	II 3G Ex nA IIC T1 ... T6 Gc X II 3D Ex tc IIIC TX °C Dc X		
			IECEx - in combination with ATEX	International		
			Hazardous areas			
			- Ex i		Zone 0 gas Zone 1 mounting to zone 0 gas Zone 1 gas Zone 20 dust Zone 21 mounting to zone 20 dust Zone 21 dust	Ex ia IIC T1 ... T6 Ga Ex ia IIC T1 ... T6 Ga/Gb Ex ia IIC T1 ... T6 Gb Ex ia IIIC T125 ... T65 °C Da Ex ia IIIC T125 ... T65 °C Da/Db Ex ia IIIC T125 ... T65 °C Db
			- Ex d		Zone 1 gas Zone 1 gas Zone 21 dust	Ex db IIB + H2 T6 ... T4 Gb Ex db IIC T6 ... T4 Gb Ex tb IIIC T85 °C Db IP66
			- Ex e ²⁾		Zone 1 gas Zone 2 gas Zone 21 dust Zone 22 dust	Ex eb IIC T1 ... T6 Gb ³⁾ Ex ec IIC T1 ... T6 Gc X Ex tb IIIC TX °C Db ³⁾ Ex tc IIIC TX °C Dc X
			- Ex n ²⁾		Zone 2 gas Zone 22 dust	Ex nA IIC T1 ... T6 Gc X Ex tc IIIC TX °C Dc X
		FM	USA and Canada			
		Hazardous areas				
- Ex d (XP)		Division 1 gas Division 1 dust	Class I, division 1, group B, C, D, T6 type 4/4X Class II or III, division 1, group E, F, G type 4/4X			
		CSA	USA and Canada			
		Safety (e.g. electr. safety, overpressure, ...)				
		Hazardous areas				
		- Ex d (XP)			Division 1 gas Division 1 dust Division 1 dust	Class I, division 1, groups B, C, D, T6 type 4/4X Class II, groups E, F, G Class III, T6 type 4/4X
	- Ex d (FP - CAN)	Zone 1 gas		Ex d IIC Gb T6/T5/T4 Ex d IIB + H2 Gb T6/T5/T4		
- Ex d (FP - USA)	Zone 1 gas Zone 1 gas	Class I, zone 1, AEx d IIC Gb T6/T5/T4 Class I, zone 1, AEx d IIB + H2 Gb T6/T5/T4				

Logo	Description	Country
	EAC (option) Hazardous areas - Ex i Zone 0 gas Zone 1 gas Zone 20 dust Zone 21 dust - Ex d Zone 1 gas Zone 21 dust - Ex n Zone 2 gas	Eurasian Economic Community
	Ex Ukraine Hazardous areas - Ex i Zone 0 gas Zone 1 mounting to zone 0 gas Zone 1 gas - Ex d Zone 1 gas Zone 1 gas Zone 1 mounting to zone 0 gas Zone 21 dust	Ukraine
	INMETRO Hazardous areas - Ex i Zone 0 gas Zone 1 mounting to zone 0 gas Zone 20 dust Zone 21 mounting to zone 20 dust	Brazil
	CCC³⁾ Hazardous areas - Ex i Zone 0 gas Zone 1 gas Zone 1 mounting to zone 0 gas Zone 2 gas Zone 21 dust - Ex d Zone 1 gas Zone 1 gas Zone 21 dust - Ex e ²⁾ Zone 1 gas Zone 2 gas - Ex n ²⁾ Zone 2 gas	China
	PAC Russia Metrology, measurement technology	Russia
	PAC Kazakhstan Metrology, measurement technology	Kazakhstan
-	MChS Permission for commissioning	Kazakhstan
	PAC Belarus Metrology, measurement technology	Belarus
-	PAC Ukraine Metrology, measurement technology	Ukraine
	PAC Uzbekistan Metrology, measurement technology	Uzbekistan

1) Only for built-in transmitter

2) Only for connection head model BSZ, BSZ-H, 1/4000, 5/6000 or 7/8000 (see "Connection head")

3) Without transmitter

Instruments marked with "ia" may also be used in areas only requiring instruments marked with "ib" or "ic". If an instrument with "ia" marking has been used in an area with requirements in accordance with "ib" or "ic", it can no longer be operated in areas with requirements in accordance with "ia" afterwards.

Explosion protection (option)

The permissible power, P_{max} , as well as the permissible ambient temperature, for the respective category can be seen on the certificate for hazardous areas or in the operating instructions.

Attention:

Only with the correspondingly suitable components is operation in Ex hazardous areas permissible.

Transmitters have own certificates for hazardous areas. The permissible ambient temperature ranges of the built-in transmitters can be taken from the corresponding transmitter operating instructions and approvals.

Certificates (option)

Certification type	Measurement accuracy	Material certificate
2.2 test report	x	x
3.1 inspection certificate	x	x
DAkkS calibration certificate	x	-

For calibration, the measuring insert is removed from the thermometer. The minimum length (metal part of the probe) for carrying out a measurement accuracy test 3.1 or DAkkS is 100 mm [3.94 in].

Calibration of shorter lengths on request.

The different certifications can be combined with each other.

→ Approvals and certificates, see website

Connection to thermowell

The many possible designs ensure that the model TR10-0 resistance thermometer can be combined with almost all possible thermowells. The most usual designs of connection are shown in the following drawings; further connections on request.

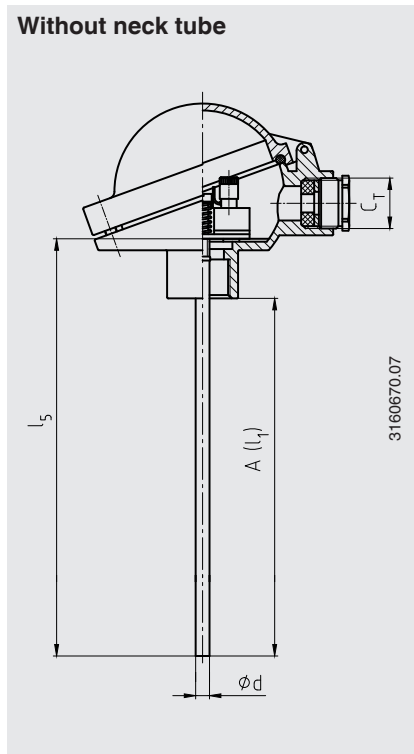
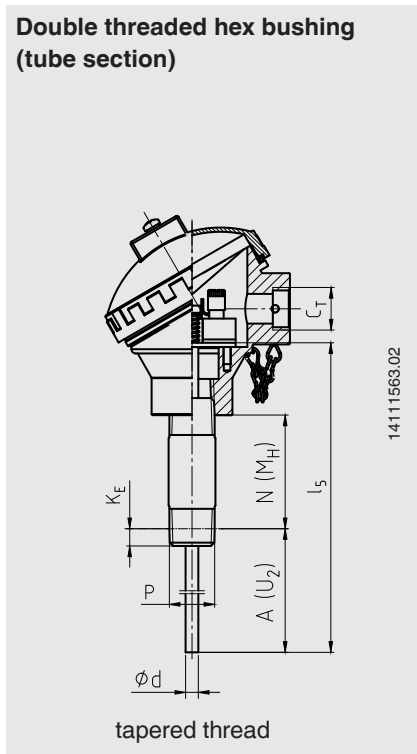
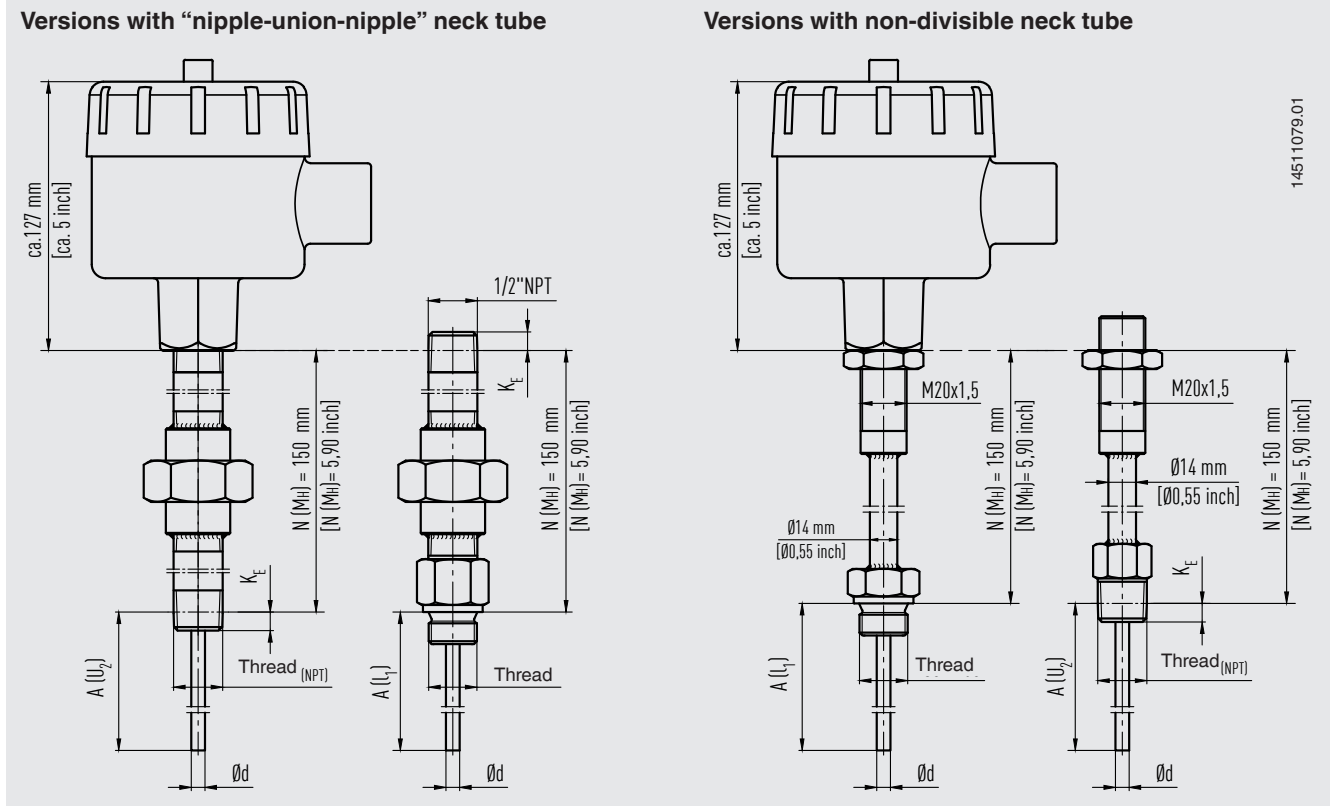

Standard thread sizes of the male threads at the neck tube

Connection thread to the thermowell

- G 1/2 B
- G 3/4 B
- M14 x 1.5
- M18 x 1.5
- 1/2 NPT
- 3/4 NPT

Connection thread to the head

- M20 x 1.5
- 1/2 NPT
- 3/4 NPT
- M24 x 1.5

Legend:

A (l₁) Insertion length (parallel threads)

A (l₂) Insertion length (tapered threads)

l₅ Measuring insert length

N (M_H) Neck length

Ø d Measuring insert diameter

C_T Thread cable entry

P Thread to the thermowell

K_E Screw-in length by hand

- with 1/2 NPT approx. 8.1 mm [0.32 in]

- with 3/4 NPT approx. 8.6 mm [0.34 in]

The figures show examples of connection heads.

Ordering information

Model / Explosion protection / Process connection / Version and material of threaded connection / Thread size / Measuring element / Connection method / Temperature range / Sensor diameter / Insertion length A / Neck length N(MH) / Certificates / Options

© 11/2021 WIKA Alexander Wiegand SE & Co. KG, all rights reserved.
The specifications given in this document represent the state of engineering at the time of publishing.
We reserve the right to make modifications to the specifications and materials.



WIKA Alexander Wiegand SE & Co. KG
Alexander-Wiegand-Straße 30
63911 Klingenberg/Germany
Tel. +49 9372 132-0
Fax +49 9372 132-406
info@wika.de
www.wika.de