

Field indicator for current loops with HART® communication

Models DIH50, DIH52

WIKA data sheet AC 80.10



for further approvals
see page 7



Applications

- Process engineering
- Plant construction
- General industrial applications
- Oil and gas industry

Special features

- Automatic measuring range configuration via HART® communication between HART® master and transmitter
- Indication range -9999 ... 99999 / bar graph
- Display for unit and diverse status messages
- Ex versions
 - Model DIH5x-I: intrinsically safe
 - Model DIH5x-F: flameproof enclosure
- HART®: Secondary master function and multidrop capability (model DIH52)



Field indicator, models DIH50, DIH52

Description

The DIH series field indicators are 4 ... 20 mA current loop indicators which can, in addition, offer a superimposed HART® communication between the connected transmitter and the control room. Thus the indication range and units are automatically adopted dependent on the settings of the connected HART® transmitter.

Common units for temperature and pressure are already saved ex works. An additional "User unit" can be programmed optionally.

With this field indicator it is possible to display range alarms as well as MIN and MAX values. Error-current signals from the connected transmitters are also detected and displayed. The indicator can be used in conjunction with any 4 ... 20 mA transmitter.

The field indicators are powered directly from the 4 ... 20 mA current loop, with a resultant voltage drop of less than 3 V.

The field indicators can be mounted directly onto a wall. An optional pipe mounting kit is available for fitting to pipes with a diameter of 1 ... 2".

The models DIH5x-B, DIH5x-Z basic modules are also available separately for mounting into other suitable cases.

The field indicators consist of an aluminium or stainless steel field case with a built-in display module.

Specifications

Specifications	Model DIH50	Model DIH52
Display principle	LCD, rotatable in 10° steps	
Measured value of display	7-segment LCD, 5-digit, character size 9 mm	
Bar graph	20-segment LCD	
Info line	14-segment LCD, 6-digit, character size 5.5 mm	
Status indicators	♥ : HART® mode (signalling of HART® parameter adoption) 🔑 : Unit lock ⚠ : Warnings or error messages	
Indication range	-9999 ... 99999	
Measuring rate	4/s	
Accuracy	±0.1 % of the measuring span	±0.05 % of the measuring span
Temperature coefficient	±0.1 % of the measuring span / 10 K	
Input signal	4 ... 20 mA	
Output signal	Analogue current signal is looped in directly	
Permissible current carrying capacity	100 mA	
Voltage drop	< DC 3 V (< DC 2 V at 20 mA); supply via current loop	
HART® functionality		
■ Access control	-	Secondary master
■ Automatically set parameters	Unit, measuring range	
■ Available commands	-	Unit, measuring range start/end, format, zero point, span, damping, polling address
■ Identified commands	Generic mode: 1, 15, 35, 44	Generic mode: 0, 1, 6, 15, 34, 35, 36, 37, 44
■ Multidrop	Not supported	Measured values are automatically taken from the HART® digital data and displayed
Electrical connection		
■ Signal input	Model DIHxx-B, DIHxx-Z: flying leads 0.5 mm ² (basic module) Model DIHxx-I, DIHxx-F, DIHxx-S: internal spring-clip terminals, connection cross-section max. 2.5 mm ² (field indicator)	
■ Signal output	Positively retained screw terminals, connection cross-section max. 2.5 mm ²	
Electromagnetic compatibility (EMC)	EN 61326 emission (group 1, class B) and interference immunity (industrial application)	

Operating conditions	
Ambient temperature	-60 ¹⁾ / -40 ... +85 °C
Functional area of the display	-20 ²⁾ ... +70 °C
Storage temperature	-40 ... +85 °C
Humidity	35 ... 85 % r. h. (non-condensing)
Vibration resistance	3 g, per DIN EN 60068-2-6
Shock resistance	30 g, per DIN EN 60068-2-27

1) Special version on request (only available with specific approvals)

2) In previous ambient temperatures < -20 °C a delayed recovery of the indication function could be expected, especially in case of low loop current.

Field case	
Material	Aluminium, stainless steel; Window from polycarbonate
Colour	Aluminium: night blue, RAL 5022 Stainless steel: silver
Cable bushings	3 x M20 x 1.5 or 3 x ½ NPT
Ingress protection	IP66
Weight	Aluminium: approx. 1.5 kg Stainless steel: approx. 3.7 kg
Dimensions	See drawing

Basic module, HART® loop module	Models DIH5x-B, DIH5x-Z
Material	Polycarbonate
Ingress protection	IP20
Weight	approx. 80 g
Dimensions	see drawing

Model overview of approvals - Explosion protection, power supply				
Model	Approvals	Ambient/storage temperature (in accordance with the relevant temperature classes)	Safety-related maximum values for current loop (± connections)	Power supply U _B (DC)
DIH50-S, DIH52-S (field indicator)	without	-20 ... +85 °C	-	14.5 ... 42 V
DIH50-Z, DIH52-Z (HART® loop module)	without	-20 ... +85 °C	-	14.5 ... 42 V
DIH50-B, DIH52-B (HART® Loop Modul)	BVS 16 ATEX E 112 X IECEX BVS 10.0037X	-40 ... +85 °C at T4 -40 ... +70 °C at T5 -40 ... +55 °C at T6	U _i < 29 V I _i < 100 mA P _i < 680 mW C _i = 13.2 nF L _i = 1.2 µH	14.5 ... 29 V
	BVS 16 ATEX E 112 X IECEX BVS 10.0037X	-40 ... +40 °C (P _i = 680 mW) -40 ... +70 °C (P _i = 650 mW)		
DIH50-B (HART® loop module)	CSA (1946893, LR 66027) Class I, Division 1 + 2, Groups A, B, C, D	-40 ... +85 °C at T4 -40 ... +70 °C at T5 -40 ... +55 °C at T6	U _i = 29 V (V _{max} < 29 V) I _i = 100 mA (I _{max} < 100 mA) P _i = 660 mW (P _{max} < 660 mW) C _i = 12 nF L _i = 2.2 µH	14.5 ... 29 V
DIH50-B (HART® loop module)	FM (FM19US0033X) Class I, Division 1, Groups A, B, C, D (IS/II/1/ABCD/T* + IS/II/0AEx ia/IIC/T*) Class I, Division 2, Groups A, B, C, D NI/II/2/ABCD/T* + NI/II/2/IIC/T*	-40 ... +85 °C at T4 -40 ... +70 °C at T5 -40 ... +55 °C at T6	U _i = 29 V I _i = 100 mA P _i = 680 mW C _i = 13.2 nF L _i = 1.2 µH	14.5 ... 29 V

Continued on next page

Model overview of approvals - Explosion protection, power supply				
Model	Approvals	Ambient/storage temperature (in accordance with the relevant temperature classes)	Safety-related maximum values for current loop (± connections)	Power supply U_B (DC)
DIH50-B (HART® loop module)	EAC (TC RU C-DE.ГБ08.V.02128) 0 Ex ia IIC T4/T5/T6 1 Ex ib [ia] IIC T4/T5/T6 DIP A20 Ta 120 °C DIP A21 Ta 120 °C	-60 ¹⁾ / -40 ... +85 °C at T4 -60 ¹⁾ / -40 ... +75 °C at T5 -60 ¹⁾ / -40 ... +55 °C at T6	$U_i = 29 \text{ V}$ ($V_{\max} < 29 \text{ V}$) $I_i = 100 \text{ mA}$ ($I_{\max} < 100 \text{ mA}$) $P_i = 660 \text{ mW}$ ($P_{\max} < 660 \text{ mW}$) $C_i = 12 \text{ nF}$ $L_i = 2.2 \text{ } \mu\text{H}$	14.5 ... 29 V
DIH50-F, DIH52-F (field indicator)	Flameproof enclosure BVS 10 ATEX E 158 IECEx BVS 10.0103 II 2G Ex db IIC T4/T5/T6 Gb Ex db IIC T4/T5/T6 Gb	-40 ... +85 °C at T4 -40 ... +75 °C at T5 -40 ... +60 °C at T6	$U_M = 30 \text{ V}$ $P_M = 2 \text{ W}$	14.5 ... 30 V
DIH50-F, DIH52-F (field indicator)	Flameproof enclosure TC RU C-DE.ГБ08.V.02128 1 Ex d IIC T6 ... T4	-60 ¹⁾ / -40 ... +85 °C at T4 -60 ¹⁾ / -40 ... +75 °C at T5 -60 ¹⁾ / -40 ... +60 °C at T6	$U_M = 30 \text{ V}$ $P_M = 2 \text{ W}$	14.5 ... 30 V
DIH50-I, DIH52-I (field indicator)	Intrinsically safe equipment ²⁾ BVS 16 ATEX E 112 X IECEx BVS 16.0075X II (1)2G IIC T4/T5/T6 Gb II (1)2D Ex ia [ia Da] IIIC T135 °C Db II 2G Ex ia IIC T4/T5/T6 Gb II 2D Ex ia IIIC T135 °C Db	-40 ... +85 °C at T4 -40 ... +70 °C at T5 -40 ... +55 °C at T6 -40 ... +40 °C ($P_i = 680 \text{ mW}$) -40 ... +70 °C ($P_i = 650 \text{ mW}$)	$U_i \leq 29 \text{ V}$ $I_i \leq 100 \text{ mA}$ $P_i \leq 680 \text{ mW}$ $C_i = 13.2 \text{ nF}$ $L_i = 1.2 \text{ } \mu\text{H}$	14.5 ... 29 V
DIH50-I, DIH52-I (field indicator)	Intrinsically safe equipment ²⁾ TC RU C-DE.ГБ08.V.02128 0 Ex ia IIC T4/T5/T6 1 Ex ib [ia] IIC T4/T5/T6 DIP A20 Ta 120 °C DIP A21 Ta 120 °C	-60 ¹⁾ / -40 ... +85 °C at T4 -60 ¹⁾ / -40 ... +70 °C at T5 -60 ¹⁾ / -40 ... +55 °C at T6 -60 ¹⁾ / -40 ... +40 °C ($P_i = 680 \text{ mW}$) -60 ¹⁾ / -40 ... +70 °C ($P_i = 650 \text{ mW}$)	$U_i \leq 29 \text{ V}$ $I_i \leq 100 \text{ mA}$ $P_i \leq 680 \text{ mW}$ $C_i = 13.2 \text{ nF}$ $L_i = 1.2 \text{ } \mu\text{H}$	14.5 ... 29 V

1) Special version on request (only available with specific approvals)

2) The installation conditions for the displays must be considered for the final application.

Output circuit DIH50-B, DIH52-B, DIH50-I, DIH52-I:

$U_o = \text{DC } 29.8 \text{ V}$

$I_o = 109.2 \text{ mA}$

$P_o = 680 \text{ mW}$

Dimensions in mm

Basic module models DIH50-B, DIH50-Z, DIH52-B, DIH52-Z

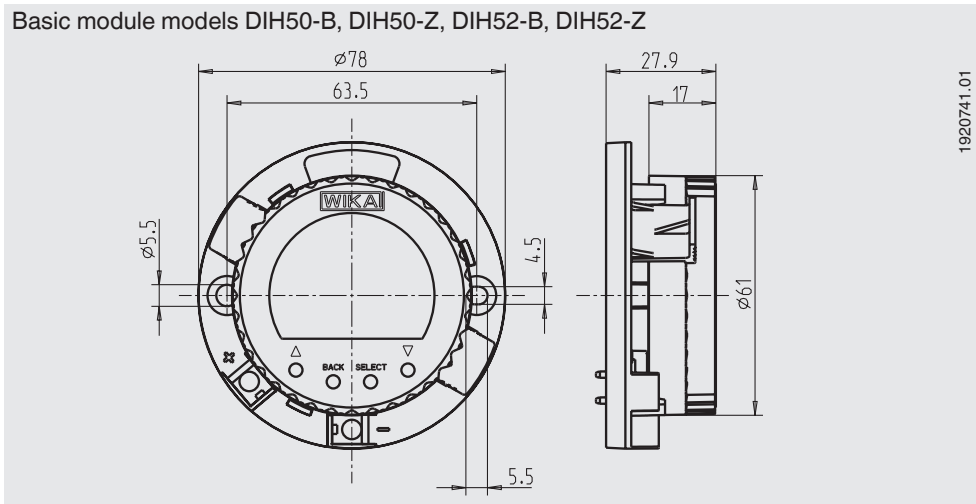

Field indicator, models DIH50, DIH52
Aluminium/stainless steel

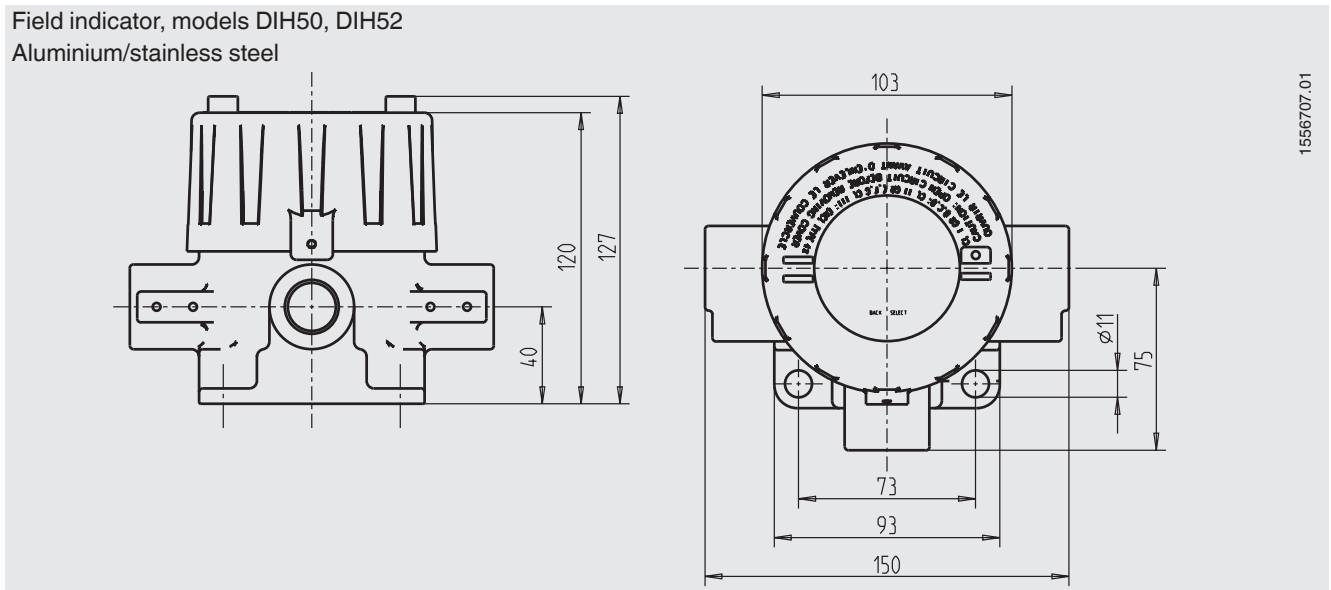

Electrical connection

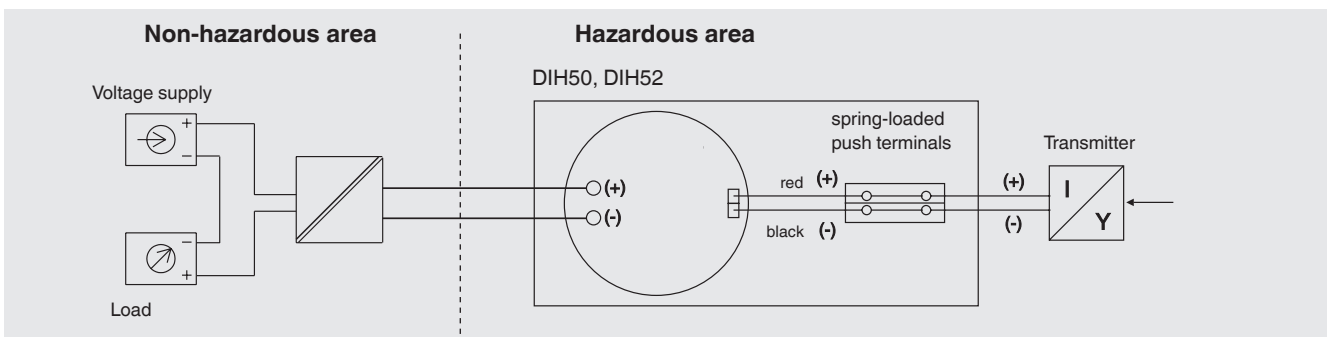



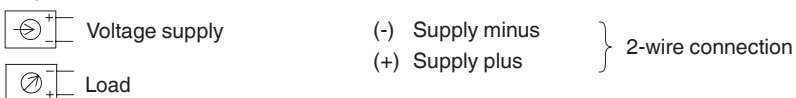

Legend:

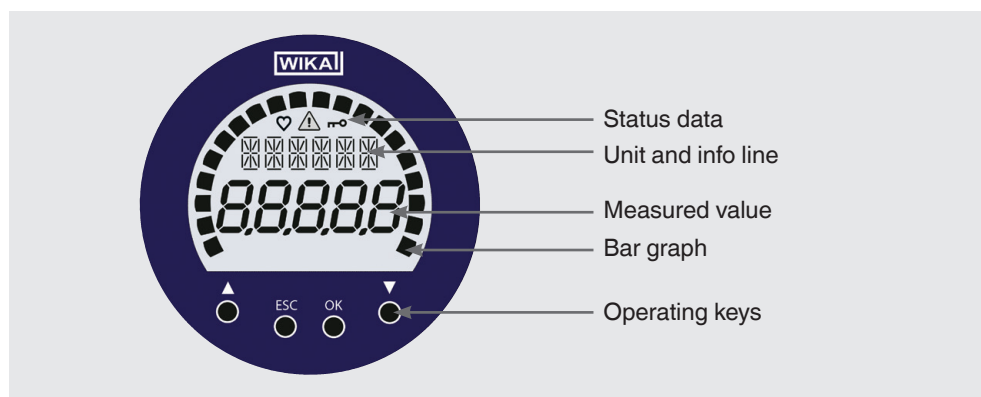











User interface



Accessories

Model	Description	Order number
Programming unit, model PU-H		
VIATOR® HART® USB 	HART® modem for USB interface	11025166
VIATOR® HART® USB PowerXpress™ 	HART® modem for USB interface	14133234
VIATOR® HART® RS-232 	HART® modem for RS-232 interface	7957522
VIATOR® HART® Bluetooth® Ex 	HART® modem for Bluetooth interface, Ex	11364254
Magnetic quick connector magWIK 	<ul style="list-style-type: none"> ■ Replacement for crocodile clips and HART® terminals ■ Fast, safe and tight electrical connection ■ For all configuration and calibration processes 	14026893

Approvals

Logo	Description	Country
	EU declaration of conformity <ul style="list-style-type: none"> ■ EMC directive EN 61326 emission (group 1, class B) and interference immunity (industrial application) ■ RoHS directive ■ ATEX directive (option) Hazardous areas 	European Union
		
	IECEx (option) Hazardous areas	International
	FM (option) Hazardous areas	USA
	CSA (option) Hazardous areas	Canada
	EAC (option) EMC directive	Eurasian Economic Community
	GOST (option) Metrology, measurement technology	Russia
-	MTSCHS (option) Permission for commissioning	Kazakhstan
	BelGIM (option) Metrology, measurement technology	Belarus
	UkrSEPRO (option) Metrology, measurement technology	Ukraine
	DNOP - MakNII (option) <ul style="list-style-type: none"> ■ Mining ■ Hazardous areas 	Ukraine
-	PESO (option) Hazardous areas	India

Manufacturer's information and certifications

Logo	Description
-	China RoHS directive

Certificates (option)

- 2.2 test report
- 3.1 inspection certificate
- DKD/DAkkS calibration certificate

Approvals and certificates, see website

Ordering information

Model / Indicator module / Explosion protection / Case material / Cable bushings / Threaded connection for cable bushing / Certificates / Options

© 02/2011 WIKA Alexander Wiegand SE & Co. KG, all rights reserved.
 The specifications given in this document represent the state of engineering at the time of publishing.
 We reserve the right to make modifications to the specifications and materials.

